

LUXI3EL



LUXI3EL PAR180RGBW V2 IP66

User Manual

Table of contents

Product introduction	3
Safety Instructions	5
Overhead Rigging	7
Electrical Operation	8
Maintenance and Cleaning	8
Control Menu	10
DMX Mode	11
Technical Specifications	13

Product introduction

Thank you for purchasing our product. Before carrying out any operations with the product, carefully read this instruction manual and keep it with you for future reference. It contains important information about the installation, usage and maintenance of the unit. Please strictly follow it.

Before unpacking the fixture, please make sure that the packaging is in good condition and that the following items will be found in the box:

- B PAR180RGBW V2 IP66 fixture
- Powercable with bare ends
- Tophat
- Omega Bracket

One of the changes between the original B PAR180RGBW and the B PAR180RGBW V2 is the humidity extractor. This humidity extractor ensures that water/condensation is reduced inside the unit. As long as the unit has power, the humidity extractor is activated.



The humidity extractor is working most efficiently if the LEDs in the fixture are turned off.

This product is intended for use in the audiovisual industry.

Description of the B PAR180RGBW V2 IP66

1. LED-Lensset
2. Menu Button
3. Display
4. Up Button
5. Down Button
6. Tilt Lock
7. Enter Button
8. Yoke
9. DMX Output 5 pin
10. Safety attachment point
11. Mains output
12. Air vent
13. Mains Input
14. DMX Input 5 pin
15. Humidity extractor

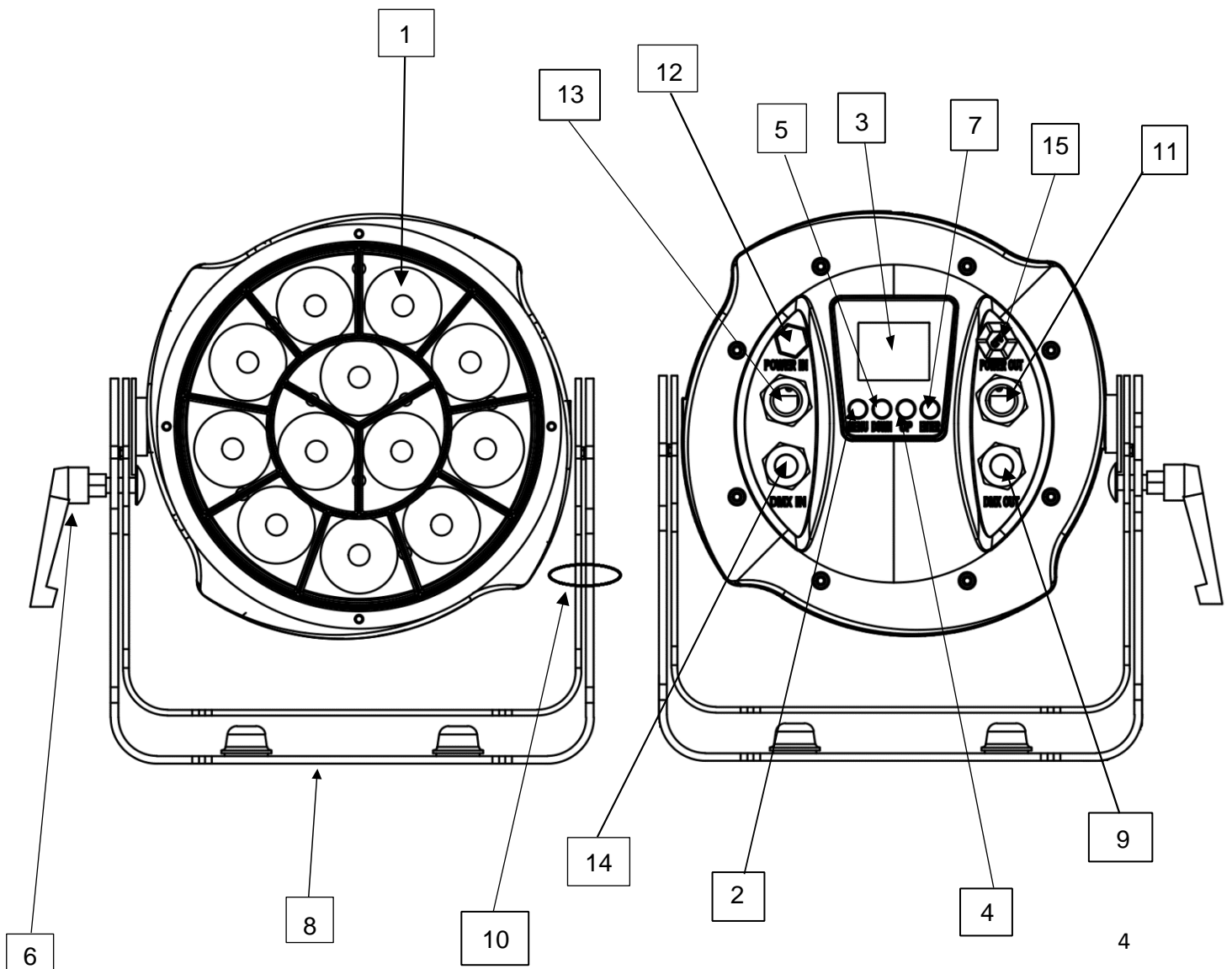













Safety Instructions

WARNING: Do not look at the light source when the device is on.

CAUTION: This housing may be hot during and after operation.

- To reduce the risk of an electric shock, do not open the device.
- Install this device in a location with adequate ventilation, at least 20 inch (50cm) from adjacent surfaces.
- Do not leave any flammable material within 20 inch (50cm) of this device while operating or connecting to power.
- Do not cover any ventilation openings as this may result in overheating.
- Keep the unit away from children.
- The electric connection should be carried out by a qualified person only.
- Make sure that the available voltage is not higher than the one stated in this manual.
- The power cord should always be in perfect condition. Switch the device immediately off when the power cord is squashed or damaged. It must be replaced by the manufacturer, its service agent or similarly qualified persons in order to avoid a hazard.
- Do not connect this device to any dimmer pack.
- ONLY connect this device to a grounded and protected circuit.
- The maximum ambient temperature is 104° F (40° C). Do not operate this device at higher temperatures.
- Always disconnect from the mains when installing, maintaining or cleaning the unit.

	Before operate this unit, please carefully read this users guide and keep if needed in future. It's necessary to respect following rules.
	The disposal of the device after lifecycle could damage the environment, need to take it to special company for recycling or return to authorized dealer.
	The products referred to in this manual conform to the European Community Directives and are therefore marked with CE logo.
	Keep this device away from children and unauthorized users, the manufacturer will not take responsibility for the damage due to any disregard of the information provided in this manual and wrong operation.
	Before operate the device, please make sure the fixture is in good housing, ensure pan and tilt can rotate in its complete range.
--0.5m	Please make sure minimal 0.5m distance need to kept between the fixture to any flammable material.
	The device can only run with 100-240V voltage, 50/60 Hz power, don't connect to any other wrong power. Disconnect the device from main power before open the shield or maintenance.
	Never look directly into the projecting lens when the fixture is power on, the light may trigger epileptic seizures in photosensitive persons or persons with epilepsy. Especially at beam effect, extreme caution and observance of these safety instructions is mandatory.
	Don't put or install the device on a surface that subject to vibration or bumps.
Ta=45°C	The device is supposed to work in the temperate range -15° C and +45° C, do not use the device when the temperate exceed this range.
	The lens, shield need to be replaced when obviously broken, never use the device when the shield is not completed closed.
	Safety I class device, need to be earth connected.
	When the fixture is hanged overhead, the safety rope must be fixed to the bottom of the device to the appropriate fixing point.
	Always carry the device by the bracket, do not take the head directly for transportation.

Overhead Rigging

The installation of the device has to be done in such a way that it can hold 10 times the weight for 1 hour without any deformation.

The operator has to make sure that all safety-related and machine-technical installations are approved by an expert, before taking the unit in operation for the first time.

Professional truss system or similar licensed suspension systems have to be used if the spotlight is used in suspension from ceiling or other constructions.

Please note: for overhead rigging in public or industrial areas, a series of safety instructions as double safety have to be followed.

Electrical Operation

IMPORTANT: The electrical installation should be carried by a qualified person only.

Please note the wire color code while connecting the 2x mains cable:

EU

- G: green/yellow color = Ground earth connection
- N: blue color = Neutral
- L: brown color = Live

US

- G: green color = Ground earth connection
- N: white color = Neutral
- L: black color = Live

This device must be earthed to comply with regulations!

This device can NOT be dimmed, do not connect on a dimmer pack!

Maintenance and Cleaning

The following points have to be considered during the inspection:

* All screws and parts of the device have to be tight and may not be corroded.

* There may not be any deformations on the housing, color lenses, fixations and installation spots (ceiling, suspension, trussing).

* The electric power supply cables must not show any damage, material fatigue or sediments.

In order to maintain the device in good condition and extend the life time, we recommend to clean the device frequently.

The cleaning of the heat sink and all external optical lenses must be carried out periodically to optimize the light output. The frequency of cleaning depends on the environment in which the fixture operates.

A detailed electric check by a certified electrician every three months, to make sure that the circuit contacts are in good condition, prevents the circuit from overheating due to poor contact.

Clean with a soft cloth using glass cleaning products. Never use alcohol or solvents. Always dry the parts carefully.

Control Menu

1) Menu tree

Default settings shadowed.

DMX Address	1-512		
Channel Mode	4/6/8/9/14 CH		
DMX Curve	1/2/3/4		
DMX State	DMX Hold/black out		
Manual Mode	Red	0-255	
	Green	0-255	
	Blue	0-255	
	White	0-255	
	Color	color 1-70	
Slave Mode	Slave		
Chase Mode *1	1-11		
Edit Chase *1	PR 1-11	SC 1-32	
Upload Chase *1	Passcode: UP/Down/UP/DOWN/Enter		
Set Up	Passcode	Passcode: UP/Down/UP/DOWN/Enter	
	Working Mode *2	Standalone (Default)	
		Master	
	Max Temp	0-65°	
	Humidity Extractor	AUTO (Default)	
		ON	
	Dimmer all	0-255	
	Factory Reset	Passcode: UP/DOWN/UP/DOWN/ENTER	
White Balance	Red	0-255	
	Green	0-255	
	Blue	0-255	
	White	0-255	
Info	Hardware V2		
	Software V***		
	Humidity	** %	
	RDM	** %	
	Working Time	5100:*****	*****H

*1 for more information about the chase menu see 'Control Menu (3) Chase function'.

*2 By default the working mode is standalone. When you want to use one par as a master, change working mode to master. We recommend always switching back to standalone when using DMX.

2) Master/Slave Function

When fixtures are connected with the signal power, there is an automatic function of master/slave build in.

When there is no DMX signal, the first fixture will act as master, and all other fixtures connected in the signal line will follow as slave. When a DMX signal is put on, it will disable the master/slave function automatically.

3) Chase Function

The chase function has 3 options:

Chase mode:

- Here you can choose between 11 different chases editable in 'Edit Chase' mode.

Edit Chase:

- Here you can edit 11 different chases (these are the same as the 11 editable modes from Chase mode).
 - o SC-01 through SC-32. (this means you can make 32 scenes for every chase)
 - o Each of these 32 scenes have the following options:
 - Red 1-255
 - Green 1-255
 - Blue 1-255
 - White 1-255
 - Fade 1-255 (You can use this to fade between different scenes)
 - Flash 1-255
 - Strobe 1-30
 - Time 1-30 (has to be at least 1-30 in order to use chase function)

Upload chase:

Here you can upload the 11 chases you made to other pars

- Step1: Go to the Set-up menu and under "Working mode" make sure you are on Standalone on all pars (Passcode up/down/up/down)
- Step2: Put the par you want to upload the chase from on Slave mode
- Step3: Put the other pars you can to put the chases on also on Slave mode
- Step4: On the par you want to upload the chase from go to "Upload Chase" and enter the passcode up/down/up/down enter

Chase mode macro's DMX channel:

- The 11 chases can also be used as a macro via DMX you can see this in the DMX chart under 9ch & 14ch mode in these channel modes is the last channel the Chase mode macro's channel.

DMX Mode

DMX addressing

The device is controlled by the universal DMX 512 protocol, the DMX address is the start channel used to receive instructions from the external controller. For independent control, each fixture must be assigned its unique address control channels. For example, this device has three channel modes: 4/6/8. If we set the mode at standard 4 channels mode and there are several models need to be independently controlled, we just simply address first fixture at 1, and second fixture at 5, third one at 10, etc.

If the devices have the same address, they will behave synchronically.

Connection

Use DMX cable with 5-pin XLR-plugs to connect the controller with the fixture or one fixture with another.

5.1.2 This device is equipped with 5-pins DMX in and out sockets only.



Pin1 =GND Pin4 =N.A.
Pin2=SIG(-) Pin5=N.A.
Pin3=SIG(+)



5.1.3 The termination is prepared by soldering a 120Ω resistor between pins 2 and 3.

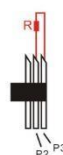
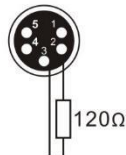

Technical Specifications

Dimensions drawing

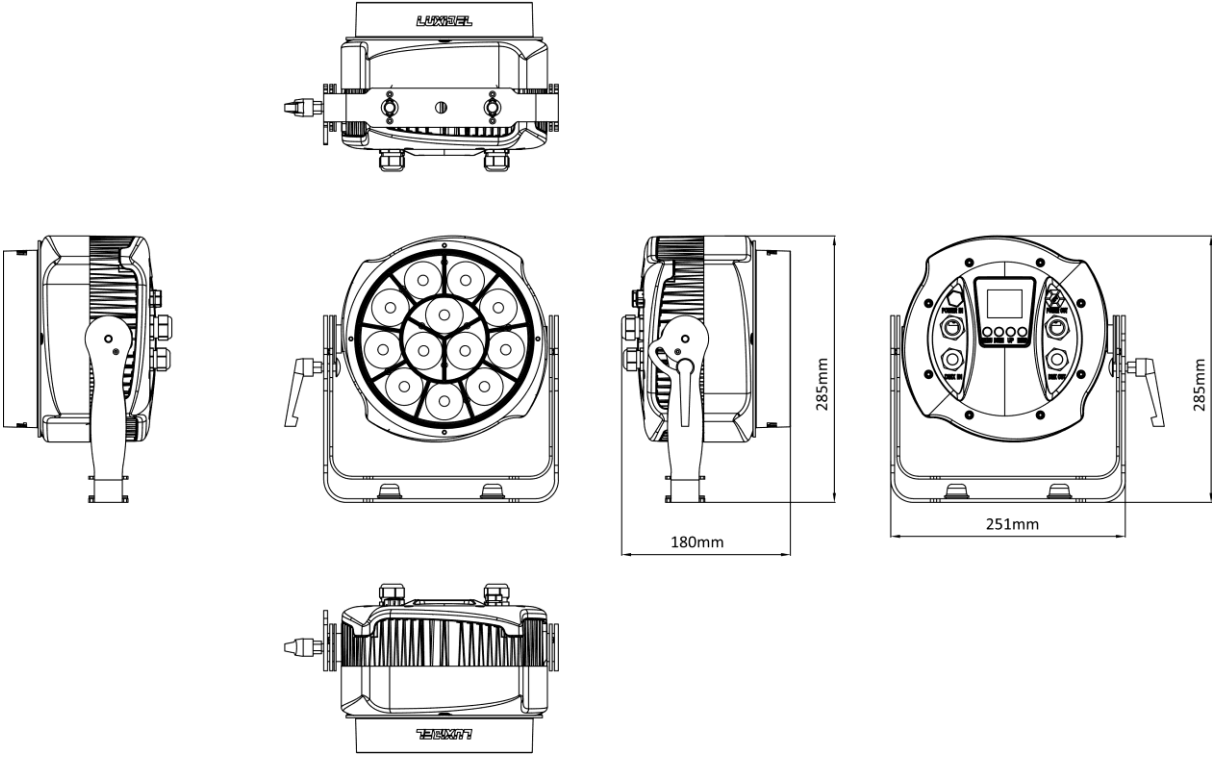

Physical

Dimensions (WxHxD): 280 x 288 x 143 mm
Packaging dimensions (WxHxD): 280 x 305 x 280 mm
4 pcs packing dimensions (WxHxD): 575 x 320 x 575 mm
Net weight: 4.7 kg
Gross weight: 5.7 kg
4 pcs packing gross weight: 24.5 kg

Mounting options

Hanging: 1 omega bracket with 2x ¼ turn quick-lock fasteners & 1 M12 hole in the middle of the omega brackets

Standing: Double bracket – adjustable opening angle
2nd suspension / safety wire: 1x molded eye on the housing to pass a safety wire or carabiner

Control

Menu control: via TFT display with 4 buttons
Control: DMX512, manual, master/slave
Dimmer mode: 0 - 100% - 8 bit
In/link: XLR 5 pin
DMX mode: 4/6/8/9/14 channels
Tilt Movement: One hand tilt locking

Optical

LED Sources: 12x 15W LED RGBW
Beam angle: 25° (fixed)
Strobe: 0-20 Hz
Dimming curves: 3
Colors: Red, Green, Blue and White | 8-bit color mix

Photometric data

Light output RGBW @ full (without tophat)

Lux @ 2m: 6210 lux
Lux @ 4m: 1523 lux
Lux @ 6m: 622 lux

Electrical

Fixture rated power: 165W

LED engine: 12 x 15W SMD LED | RGBW 4 in 1

Input power: 100-240V ~ 50/60Hz | Auto switching power supply

In/Link: PowerCON TRUE1 | max link current: 10A

IP rating: IP66

Cooling: electronic heat control (no fans)

Refresh rate: 1.200 Hz

Accessories

1x Tophat

1x Omega Bracket

Contact

Luxibel

Bedrijvenpark De Veert 13/004

2830 Willebroek

Belgium

+32 3 60 76 50

info@luxibel.com

www.luxibel.com

2022